

TESTING

TESTA

CT/TT 300 CB

ENVIRONMENTAL CHAMBER
FOR COLD BEND / COLD IMPACT TESTING OF WIRES & CABLES.





ARALAB is a company specialised in designing, developing, manufacturing and servicing of high quality climatic chambers and controlled environment rooms.

Since 1985 we have been perfecting ways to create and control temperature, humidity, light, air flow and many other environmental conditions.

Only the highest quality components are used to manufacture our chambers so customers can have the best equipment for their research and testing purposes.

Control the environment, Your own climate.



TESTA temperature and humidity testing chambers offer highly precise and reproducible conditions for climatic and temperature testing in many industries.

COMMON APPLICATIONS INCLUDE:

- ENVIRONMENTAL TESTING
- ELECTRONICS, AUTOMOTIVE, AEROSPACE,
- BUILDING MATERIALS, MILITARY EQUIPMENT, MATERIALS IN GENERAL RESEARCH
- QUALITY CONTROL
- PRODUCTION FACILITIES



KEY FEATURES

- The most advanced technology in climate control
- Internal aerodynamic optimisation to ensure uniformity of climatic conditions
- Time saving features with easily configurable testing programs that can run, start and stop automatically
- Highly resistant stainless steel interior for maximum durability and easy cleaning
- Flexible interior with height adjustable and removable stainless steel shelves
- Nonpolluting construction and cooling system
- Compliant with international standards and requirements EN, IEC, DIN, ISO, NP and UNE

TEMPERATURE AND HUMIDITY CONTROL RANGES

● ● ● ● TESTA TT CHAMBERS - TEMPERATURE ONLY

TESTA TT CHAMBERS	TEMPERATURE RANGE	HUMIDITY RANGE
TESTA TT E20		N/A
TESTA TT E50	-52°C to +180°C	N/A
TESTA TT E75	-75°C to +180°C	N/A





● ● ● ● TESTA CT CHAMBERS - TEMPERATURE AND HUMIDITY

TESTA CT CHAMBERS	TEMPERATURE RANGE	HUMIDITY RANGE
TESTA CT EP, EC & ECP 20		10 to 98% RH
TESTA CT EP, EC & ECP 45	-52°C to +180°C	10 to 98% RH
TESTA CT EP, EC & ECP 75	-75°C to +180°C	10 to 98% RH





TEMPERATURE AND HUMIDITY CONTROL RANGES

● ● ● ● TESTA CT TESTING CHAMBERS



Performance in CLIMATIC testing range | only TESTA CT chambers

TEMPERATURE RANGE		10°C to 90°C
TEMPERATURE UNIFORMITY		± 0,1°C to ± 1,0°C ^(1b)
TEMPERATURE FLUCTUATION ^(1a)		± 0,1°C to ± 0,3°C ^(1b)
HUMIDITY RANGE		10% RH to 98% RH
HUMIDITY FLUCTUATION ^(1a)		± 0,5% RH to ± 3% RH

Performance in TEMPERATURE testing | TESTA TT and TESTA CT chambers

TEMPERATURE RANGE		-75°C, -52°C up to 180 °C
TEMPERATURE UNIFORMITY ^(1a)		± 0,5°C to ± 1,5°C
TEMPERATURE FLUCTUATION ^(1a)		± 0,1°C to ± 0,5°C
TEMPERATURE RATE OF CHANGE HEATING ^(2a)		From 2,5°C to 4,5°C / min 10°C / min in "10K" models
TEMPERATURE RATE OF CHANGE COOLING ^(2a)		From 2,5°C to 4,5°C / min 10°C / min in "10K" models

Other technical data

NOISE LEVEL		55 to 64 dBA
ELECTRICAL CONNECTION		3/N/PE AC 400V ± 10% 50Hz

Performances measured in factory with ambient temperatures between 20°C and 25°C.

(1a) Measurements at center of test space, with empty chamber and no optional accessories; (1b) in temperature range up to 150°C;

(2a) According to IEC/EN 60068-3-5/6. Values will vary with TESTA CT/TESTA TT model, internal volume, compressor type and condenser cooling system. Temperature rate of change can be adjusted to comply with the needed heating / cooling speed requirements. Optional accessories are available for more demanding heating and cooling temperature change rates.

DIMENSIONS AND DRAWINGS

● ● ● ● TESTA TT / TESTA CT 300

EXTERNAL DIMENSIONS (HxWxD) (mm)		1 840 x 1 236 x 1 350
INTERNAL DIMENSIONS (HxWxD) (mm)		715 x 634 x 600

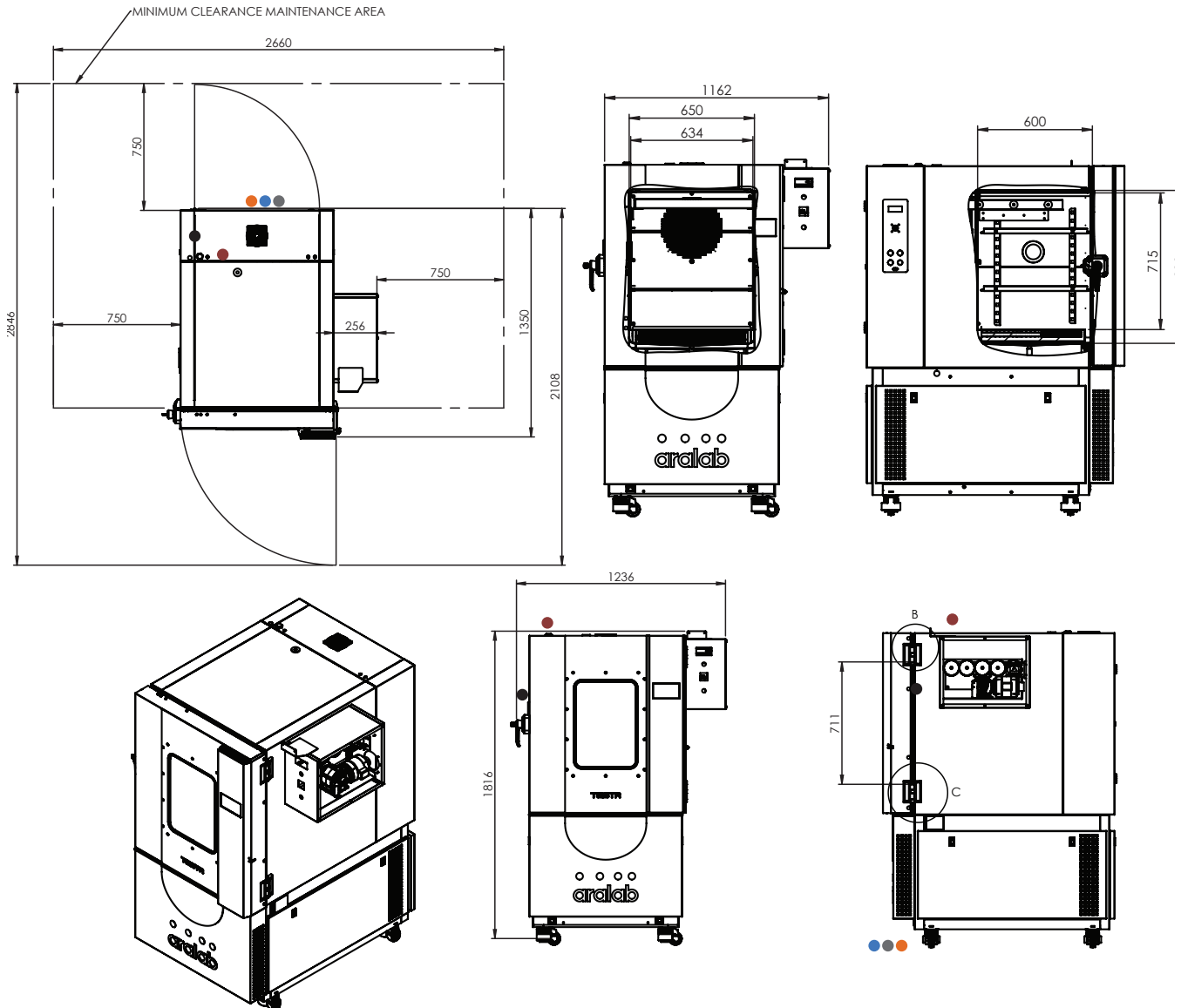

- Standard refrigeration system is air cooled
- Services hub installation needs:
 - 1/2" demineralized water supply
 - 50mm water drain at floor level
- Electrical cabinet installation needs:

Supply power ECP50:
400VAC, 50Hz, 16A / 3-Phase + Neutral + Ground
Electrical protection: Circuit breaker 3 x 16A + N with 300mA differential
3-Phase electrical cable RV-K 5G4 on the top

Supply power ECP75:

- 400VAC, 50Hz, 50A / 3-Phase + Neutral + Ground
- Electrical protection: Circuit breaker 3 x 63A + N with 300mA differential
3-Phase electrical cable RV-K 5G10 on the top

● **RJ45 communications port**

● **Water cooled option:**

- Water flow: up to 2 000 l/hr (at 25 °C)
- Intake pressure: 2 to 5 bar
- Water entry and exit pipe: 1" or 28mm
- Differential pressure between entry and exit: $\geq 2,5$ bars
- Maximum temperature of water entry: 26 °C
- Minimum temperature of water entry: 16 °C
- Recommended temperature of water entry: 18 °C

EQUIPMENT DESCRIPTION



TEMPERATURE

TEMPERATURE SENSORS

- One (1) PT 100 Class A
- One (1) PT 100 Class A, movable sensors for flexible placing inside chamber

HEATING

- By stainless steel electric heaters located in the air treatment tunnel

COOLING

- Air cooled hermetic compressor group (low noise and high efficiency) with enforced ventilation and without CFC's. Water-cooled condensers are also available as standard in -75°C models or an option for models with temperature cooling rate upgrades.

THERMAL SECURITY

- Safety thermostat with High / Low temperature configuration, with automatic stop of all thermic systems.
- High / Low temperature alarms programmed in the controller, with mute function. This function will not stop the chamber and it is only used to record the occurrence and to call the attention of the users with an audible alarm.

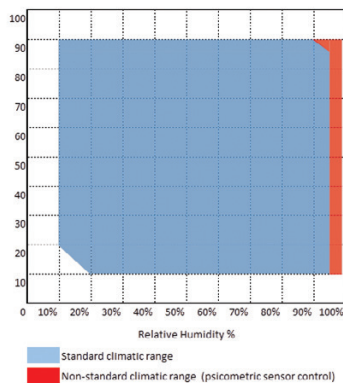

HUMIDITY (TESTA CT CHAMBERS)

HUMIDITY PRECISION

(in the interior of the chamber, at 5 cm from walls, floor and ceiling)

- In Time $\leq \pm 1,0\%$ RH
- In Space $\leq \pm 2,5\%$ RH

HUMIDITY SENSORS

- To measure and control humidity Aralab uses two different sensor technologies: Psychrometric, Capacitive, or both simultaneously. Consult Aralab for technical support on the appropriate selection.

HUMIDITY / DRYING

- Humidity: Through thermostatic bath with dew point control
- Drying: Through thermostatic bath with dew point control and additional dry coil

HUMIDITY SENSORS: HUMIDITY VS. TEMPERATURE RANGES GRAPHIC

- For climatic tests that require humidity and temperature ranges highlighted in red on the graph, a Psychrometric sensor is recommended (EP and ECP models). Please consult Aralab for help on the choice between these two models.





SECURITY

- Automatic stop function in case of water failure, with indication on the controller; High / Low Temperature alarms; High / Low humidity alarms.

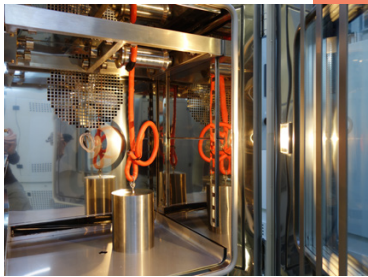

CONSTRUCTION

- Interior: AISI 304 hermetical welded, vapour tight, stainless steel
- Exterior: Zinc mild steel with epoxy coating finish (color RAL 7035)
- Insulation: Rock Wool
- Interior illumination: Halogen lamp 12V (only available with optional window)
- Door: Double silicone joints and anti-condensation heating frames (optional window)
- Reinforced Floor Plate

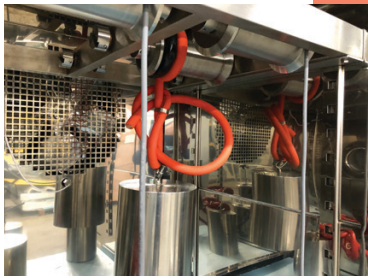

AIR FLOW / VENTILATION

- Air Flow: Forced through 1 ventilator/fan.
- Air Renovation: By lateral port, also for compensating pressure.



CUT-OFF PANEL, SECURITY AND COMMUNICATIONS

Left lateral panel of the chamber and equipped with:

- High / Low safety thermostat
- Main Power switch
- Audible alarms
- RJ45 communications port



WINDING MECHANISM

- Programmable turns with automatic stop
- Programmable speed (RPM)
- Selectable start speed
- Automatic winding and unwinding

PROGRAMABLE WINDING MECHANISM WITH 6 MANDRELS

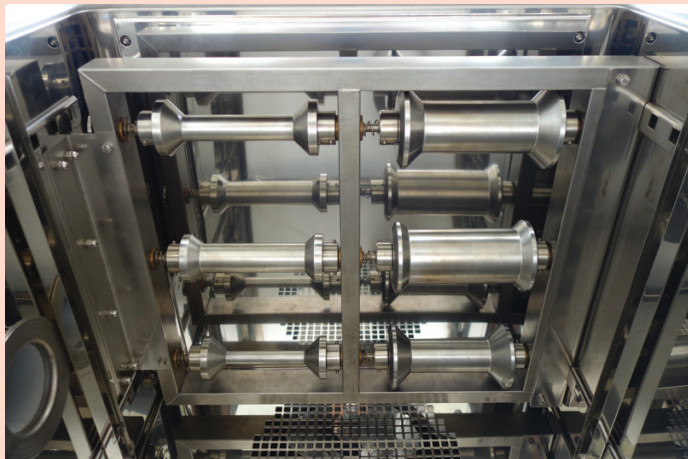

CLIMAPLUS HMI CONTROLLER

Programmable PLC exclusively developed for Aralab chambers.

Multi language (PT, ES, EN, FR, DE, IT) easy to use touch-screen interface.

90mm x 155mm (7 inch) multicolor display.

Resolution of 0,1°C for Temperature and 0,1% for Relative Humidity.

High performance temperature and humidity control with value correction in all ranges.

Capability for creating 50 programs of 50 segments each.

Internal non volatile memory for storing test data.

Automatic restart of tests due to power failure, without losing data and restarting test where it was interrupted.

Real-time monitoring of all functions and control of equipment.

Manage control settings via MODBUS/TCP.

Possibility of programming a delay of the beginning of test.

Monitoring and recording of all alarms.

Possibility of performing events by external commands.

Several outputs for connecting computers or other devices.

Alarms management.

Graphic representation of the tests and conditions.

Remote access through VNC server.

Possibility of running computer test programs and export them to the controller.

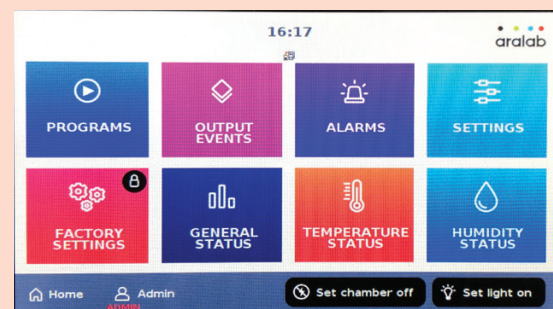
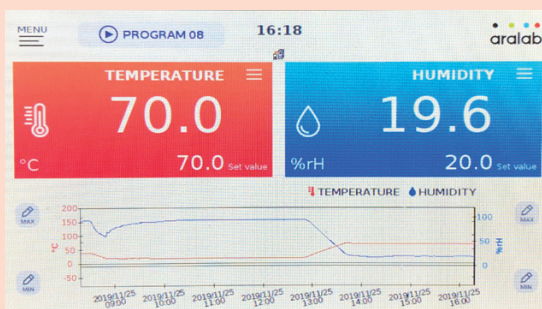

FITOLOG SOFTWARE

The FitoLog software pack is a set of applications designed to facilitate the managing, monitoring and recording of programs and data from the TESTA chambers. It consists of 3 applications: **FitoLog**, **FitoLogView** and **FitoProgram**.



FITOLOG

Records and displays in real time all data and details related to the set-points, running variables and equipment behaviour. It also retrieves information about the active components of the chamber, running processes, errors, alarms and allows the configuration of periodic or alarm triggered remote notifications (by email or SMS, depending on existing connections and accessories).

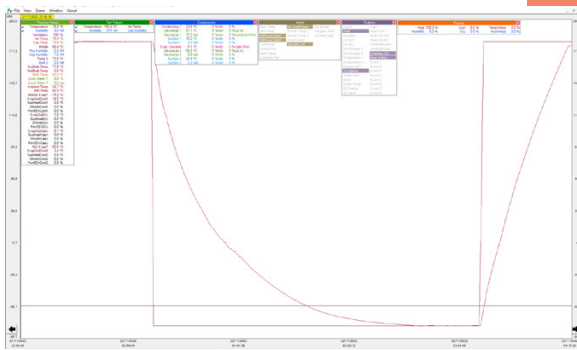

FITOLOGVIEW

It is a working tool to process the data recorded by the FitoLog program. One can view, print and export the log contents to other file types, and analyse the data in other data management software.

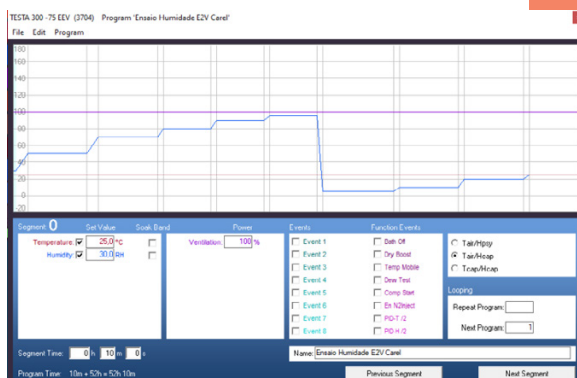

FITOPROGRAM

This application simplifies the creation of programs and its integration on the chamber ClimaPlus controller. Can be designed and linked to create detailed environmental profiles and simulations.

NOTIFICATIONS, FAST DIAGNOSTICS AND PROMPT TROUBLESHOOTING

With FitoLog it is possible to gather data from each of the chambers systems, which makes it a very useful tool to diagnose any necessary maintenance. This tool works as the "black box" of the equipment, giving Aralab technicians the necessary data to remotely carry out a fast and efficient diagnostic. All that is needed is a FitoLog file.

COMMON ACCESSORIES

PLEASE CONSULT ARALAB FOR OTHER ITEMS

Software pack FitoLog and FitoLogView.

Observation anti-condensation windows in multi layered glass.

Water demineralizer (for TESTA CT Chambers).

Integrated water tank.

Air dryer.

Additional entry ports.

Calibration certificate from accredited external laboratory.

Faster heating / cooling temperature change rates up to 10k/minute.

WINDOW OPTION



The observation window is composed of a multilayered glass with optimum levels of thermal insulation. The interior and exterior glasses have a heating system that is activated in cold cycles and damp heat to prevent condensation at the surface.

OTHER TESTING ACCESSORIES AND DEVICES

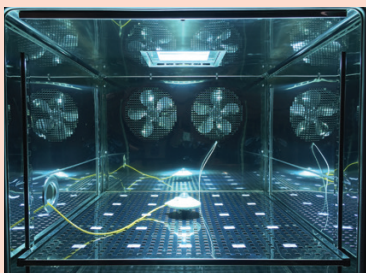

UV/Sun radiation aging simulator



Combined climatic and vibration test



DIN 50017 – Condensation water test atmospheres

INSTALLATION REQUIREMENTS

INSTALLATION SITE

The place should be easily accessible, according to equipment dimensions and weight. It should have good air circulation and a room temperature between 10° and 26°C. The floor should be leveled and a minimum distance of 50cm from the walls and other equipment must be kept.

ELECTRICAL SUPPLY

Near the equipment with the specified requirements.

HUMIDIFICATION CIRCUIT AND DEMINERALIZED WATER (FOR TESTA CT MODELS)

The humidification circuit works exclusively with distilled or demineralized water. For this circuit, a water admission pressure of 1 to 6 bares and conductivity of $\leq 50\mu$ Siemens is required.

WATER CIRCUIT FOR COOLING CONDENSER

(optional accessory for all models, or specific for models with Temperature/Cooling change rate upgrade)

A cold water circuit is required for the cold system condenser. Technical characteristics:

- Water flow: up to 2000 liters/hour (at 25°C)
- Intake pressure: 2 to 5 bar
- Water entry and exit pipe: 1" or 28mm
- Differential pressure between entry and exit: $> 0,5$ bars
- Maximum temperature of water entry: 26°C
- Minimum temperature of water entry: 16°C
- Recommended temperature of water entry: 18°C

DRAIN

At floor level and near the equipment. The draining of the humidification and cooling systems water is done by gravity. For a correct draining there should be a minimum inclination of 10° in a descending trajectory from the chambers draining pipe until the sewage system.

Features and specifications are subject to change. Aralab continuously studies ways to further develop its products to achieve better performances and overall product quality. As a result, characteristics and specifications provided in this document may be subject to changes.

Let's meet!

aralab@aralab.pt

www.aralab.pt

T: +351 219 154 960



Configure your
chamber 

See it on the
Showroom 

 /AralabChambers

 /company/aralab

 /user/AralabChambers

 /Aralab_

 /aralabchambers



Control the environment

Your own climate